

Krężniki gładkie

Smooth roller • Tragrolle • Rouleau lisse

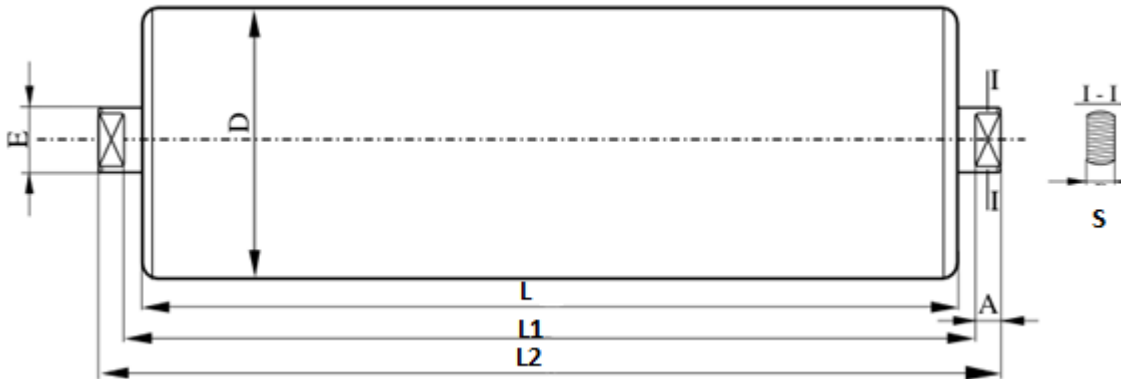

Typowe średnice rury Ø D Tube Rohr Tube	L	L2	A	s	Łożysko Bearing type Lagertyp Type de roulement
Ø 51x3,2 Ø 60,3x3,0 Ø 63,5x3,2 Ø 88,9x4,0 Ø 108x4,0 Ø 133x4,0	160	186	9	14	6204 C3
	200	226			
	250	276			
	315	341			
	380	406			
	465	491			
	500	526			
	530	556			
	600	626			
	670	696			
	700	726	15		
	750	788			
	800	838			
	900	938			
	950	988			
	1000	1038			
	1150	1188			
	1250	1288			
	1400	1438			
	1600	1638			
1800	1838				
2000	2038				

Na życzenie klienta wymiary inne od katalogowych ustalane są indywidualnie.

Dimensions different from those in the catalogue can be set individually, at the customer's request.

JĘDRZYCHOWICE 110A • 59-900 ZGORZELEC • www.gumzamet.pl tel./ fax 75/77-88-427

GUMZAMET A&B KOZERA SP.K.

Inne rodzaje osi

other types of axles • andere Achsenarten • autres types d'axes

(dla krążników gładkich $\emptyset 51/\emptyset 60,3/\emptyset 63,5/\emptyset 20$)

$\emptyset d$	M	S
20	-	8
20	12	14
20	12	15

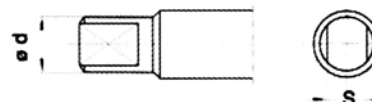
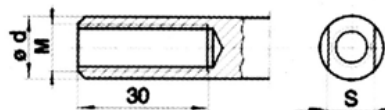

(dla krążników gładkich $\emptyset 89/\emptyset 20$)

$\emptyset d$	M	S
20	12	14
20	12	15
20	16	-
20	20	-

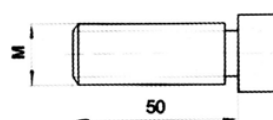
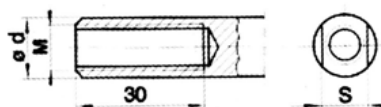

(dla krążników gładkich $\emptyset 108/\emptyset 133/\emptyset 20$)

$\emptyset d$	M	S
20	12	14
20	12	15
20	16	-

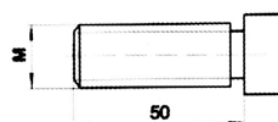
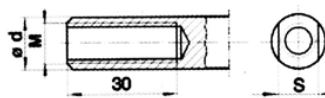

Typowe średnice rury Ø D Tube Rohr Tube	L	L2	A	s	Łożysko Bearing type Lagertyp Type de roulement
Ø 133x4,0	250	282	12	18	6205 C3 6305 C3
	315	347			
	380	412			
	465	497			
	530	562			
	600	632			
	670	702			
	700	732			
	750	802			
	800	852			
	900	952	22		
	950	1002			
	1000	1052			
	1150	1202			
	1250	1302			
	1400	1452			
	1600	1652			
	1800	1852			
	2000	2052			

Na życzenie klienta wymiary inne od katalogowych ustalane są indywidualnie.
Dimensions different from those in the catalogue can be set individually, at the customer's request

Inne rodzaje osi

other types of axles • andere Achsenarten • autres types d'axes

(dla krążników gładkich Ø 133/ Ø25/6205)

Ø d	M	S
25	12	18
25	16	18

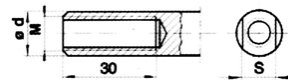

(dla krążników gładkich Ø 133/ Ø25/6305)

Ø d	M	S
20	-	14
20	-	15
20	12	14
20	12	15
25	12	18
25	16	18

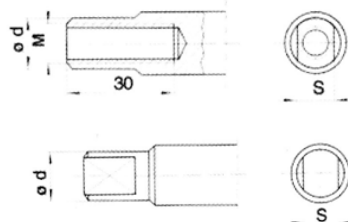

Typowe średnice rury Ø D Tube Rohr Tube	L	L2	A	s	Łożysko Bearing type Lagertyp Type de roulement
Ø 133x4,0 Ø 159x4,0	250	282	12	22	6206 C3
	315	347			
	380	412			
	465	497			
	530	562			
	600	632			
	670	702			
	700	732	20		
	750	798			
	800	848			
	900	948			
	950	998			
	1000	1048			
	1150	1198			
	1250	1298			
	1400	1448			
	1600	1648			
1800	1848				
2000	2048				

Na życzenie klienta wymiary inne od katalogowych ustalane są indywidualnie.
Dimensions different from those in the catalogue can be set individually, at the customer's request

Inne rodzaje osi

other types of axles • andere Achsenarten • autres types d'axes

(dla krążników gładkich Ø 133/ Ø 159/6206)

Ø d	M	S
25	-	18
25	12	18
25	16	18
30	12	22
30	16	22

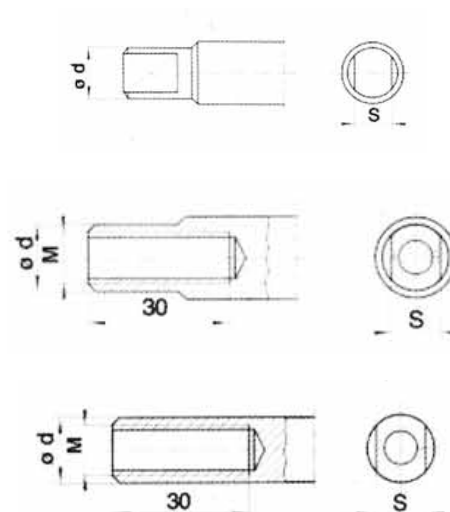

Typowe średnice rury Ø D Tube Rohr Tube	L	L2	A	s	Łożysko Bearing type Lagertyp Type de roulement
Ø 159x4,0	315	347	12	18	6305 C3
	380	412			
	465	497			
	530	562			
	600	632			
	670	702			
	700	732			
	750	798	20		
	800	848			
	900	948			
	950	998			
	1000	1048			
	1150	1198			
	1250	1298			
	1400	1448			
	1600	1648			
	1800	1848			
	2000	2048			

Na życzenie klienta wymiary inne od katalogowych ustalane są indywidualnie.
Dimensions different from those in the catalogue can be set individually, at the customer's request

Inne rodzaje osi

other types of axles • andere Achsenarten • autres types d'axes

Ø d	M	S
25	-	18
25	12	18
25	16	18

